

DANCOVER[®]



PARTY TENT SEMI PRO

7x7 - 2,3M

DANCOVER[®]

.com

Safety Advice

Attention

In some countries approval is needed to set up a marquee/tent larger than 75 m². It is your responsibility to comply with local rules and regulations and to ensure that the marquee/tent is assembled correctly.

In case of bad weather conditions, it is your responsibility to ensure the marquee/tent is safely secured and that the marquee/tent does not cause damage to others.

Do not use open fire, welding equipment or other sources which can ignite, inside or close to the tent.

The marquee/tent must be safely secured. We recommend you secure your marquee/tent with straps and pegs as soon as it is assembled.

Make sure to check if the marquee/tent is covered by your home contents insurance.

Marquees/tents must be evacuated under extreme weather conditions.

In the event of snow always remove snow from the roof of the marquee/tent regularly to prevent snow from building on the roof as heavy snow can cause the marquee/tent to collapse.

In the event of rain there is a risk of rain puddles building up on top of the roof of the marquee/tent. Heavy rain puddles can cause the roof to collapse. It is your responsibility to ensure rain puddles do not build up. As a precaution, make sure the roof of the marquee/tent is stretched out properly and adequately over the side frames of the marquee/tent and remove rain water regularly.

Do not unpack or repack your marquee/tent in freezing temperatures. In case of temperatures below zero always unpack and repack your marquee/tent indoors to avoid the risk of cracking parts.

The marquee/tent must be totally dry before you repack and store it to avoid mildew.

Note: Marquees are intended for events and other arrangements and are as such only meant for short term temporary assembly and the following disassembly. Dancover warranty applies only to the normal use of the Product, normal wear and tear excepted, in accordance with written use instructions or manual. The warranty does not apply to damage caused by accident, abuse, misuse, or modification of the Product.

Warranty Information

Please visit dancovershop.com for information on warranty.

Please always check our website for the latest safety advice and manual.

Warning

1

The pipes are covered in oil. Before you set up your tent please remove the oil carefully to keep the cover clean.

2

Take note that the tent needs to be handle with care to avoid damages.

3











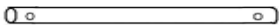
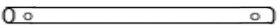







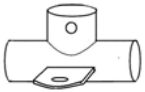
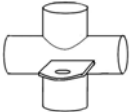

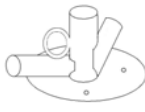
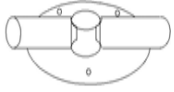
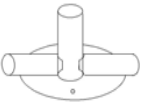



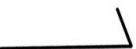

Do not force the frame as they may be damage in the process.

4

Tents are meant as temporary shelters and must be evacuated under extreme weather conditions.

Please select a suitable site for the tent to avoid damage to underground sprinkler systems, water, gas or electrical lines.

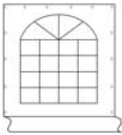
7x7m-2.3 PARTY TENT SEMI PRO

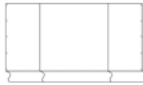
2188mm Ø50mm 		2210mm Ø38mm 		1700mm Ø50mm 		1750mm 		640mm 		110° 		140° 	
1.	8PCS	2.	27PCS	3.	16PCS	4.	8PCS	5.	4PCS	7.	4PCS	8.	2PCS
140° 		110° 						90° 		90° 			
9.	2PCS	10	4PCS	11.	4PCS	12.	4PCS	13.	2PCS	14.	2PCS	15.	4PCS
													
16.	4 pc	17.		4PCS		18.		4PCS		19.super peg	6pcs	20.spiral peg	4pcs
						M6x25mm 		M6 		M8x50mm 			
21.middle peg	8 pcs	22.small peg	36 PCS			24.Spanner	2PCS	25.Screw	16PCS	26.Wing nut	16pcs	27. Screw	54pcs
M8x60mm 													
29. Screw	48pcs	30.Nut	102pcs	31. Long bungeeball	132PCS			33.Rope	4PCS			34.Roof	1 pcs
													
35.Sidewall	6PCS	36. Endwall Large door		1PC		37.Endwall Small door		1PC					

7x7m-2.3 PARTY TENT SEMI PRO

I

Select a flat surface for the tent. Unpack the boxes and check if all listed parts are included. Assemble the roof frame by mounting parts 7-12 on the pipes (Parts 2 and 3). Use the screws to firmly attach the parts.

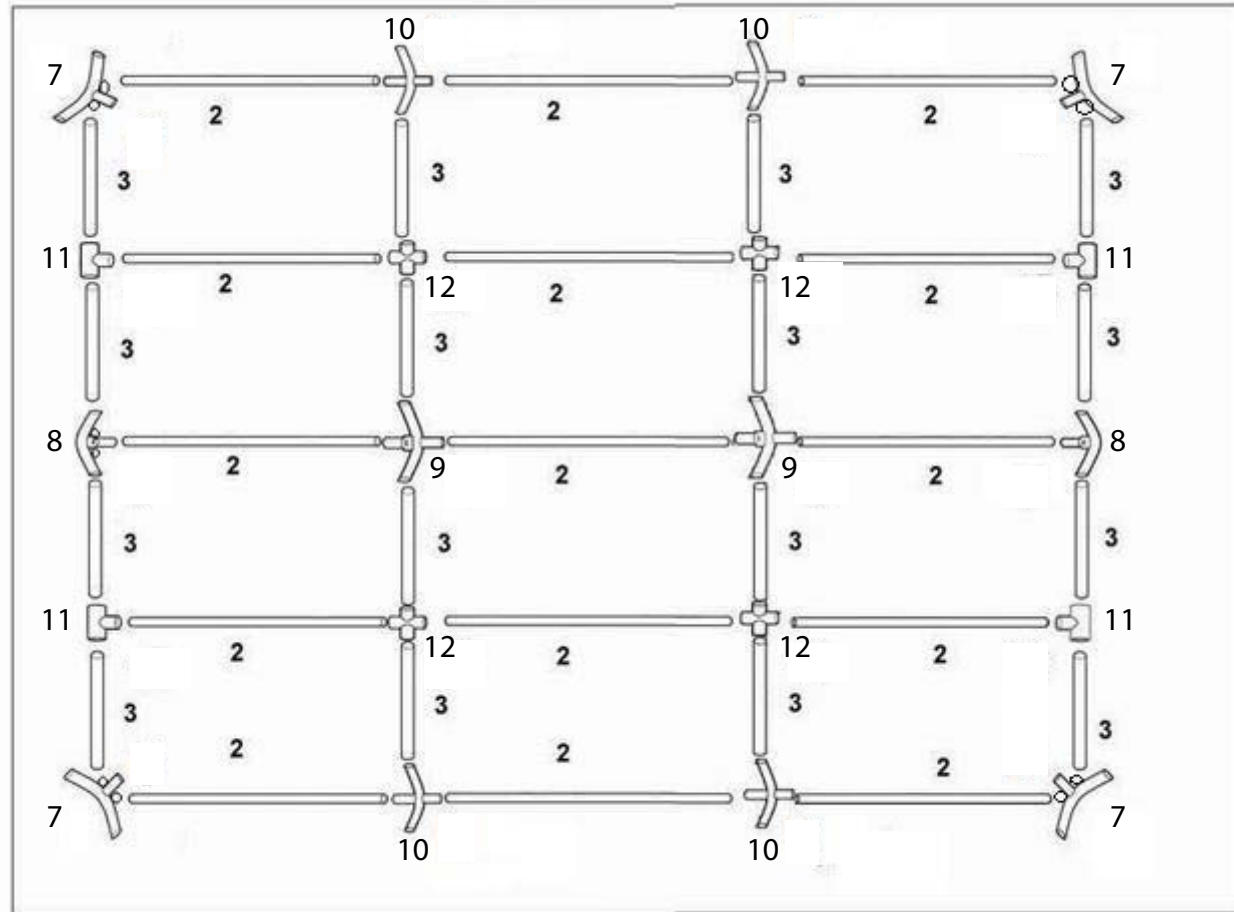

7x7m-2.3 PARTY TENT SEMI PRO

II

Attach the gable bars (part 4 and 5) using screws (25) and wing nuts (26). Strengthen the frame with the turnbuckle set (17).

Long screws are used in all connections between pipes $\text{\O}50\text{mm}$ and $\text{\O}54\text{mm}$.

Short screws are used in all connections between pipes $\text{\O}42\text{mm}$ and $\text{\O}38\text{mm}$.

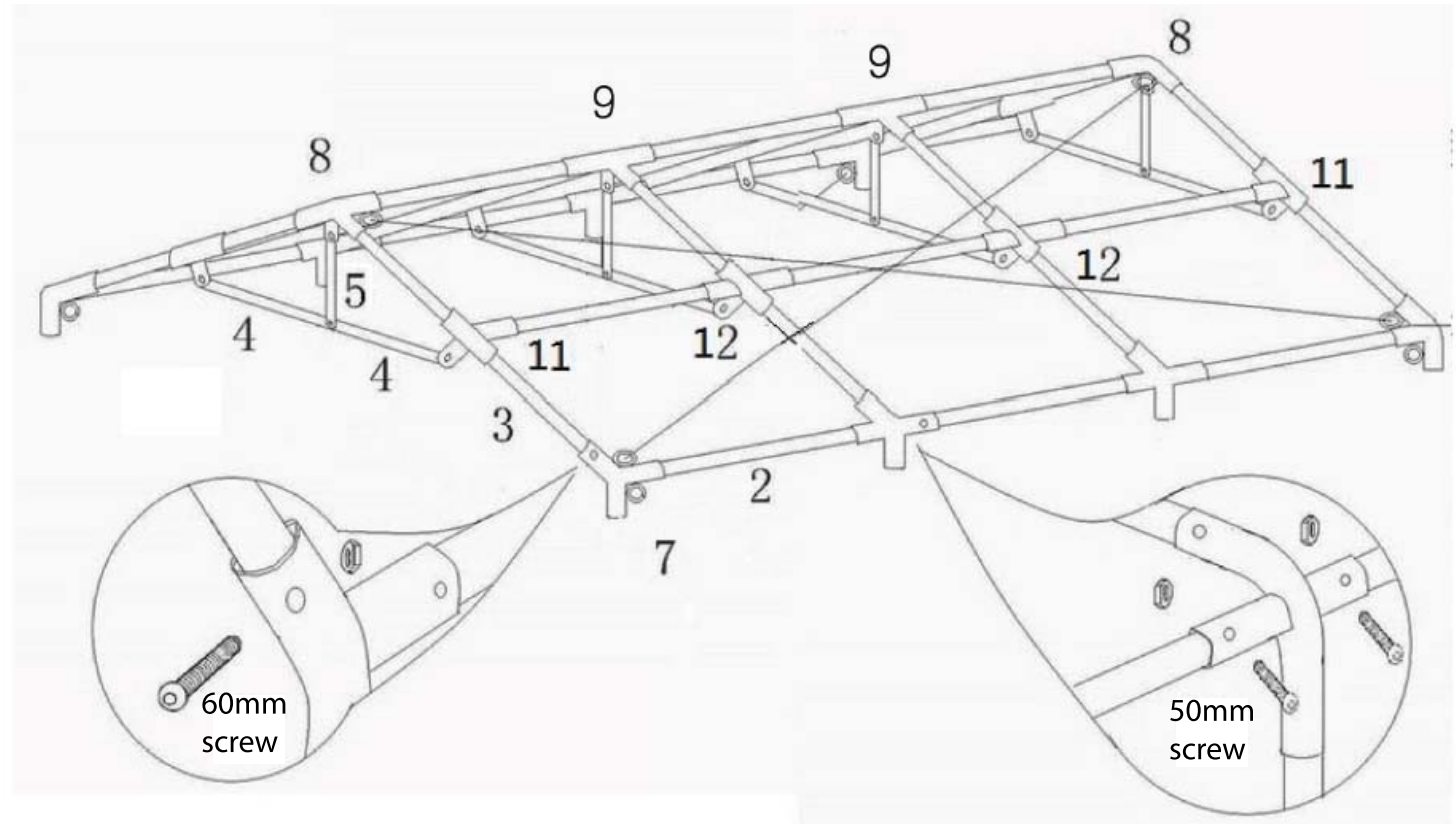

7x7m-2.3 PARTY TENT SEMI PRO

III

Lift one side of the tent frame and attach the legs(1). Place the roof onto the frame and use the bungees to fasten it. Be sure not to put too much tension on the bungees in order not to make attaching the other side more difficult.

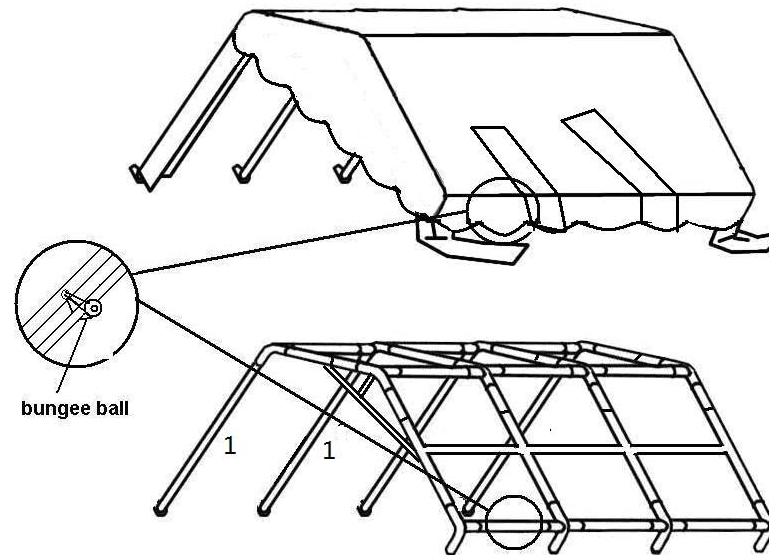

IV

Attach the legs on the other side and install the feet(13-16) at the bottom. Use the long ground pegs to fasten the feet to the ground. Reinforce the side frame by attaching the turnbuckle set (18) as shown on the drawing to the right. Complete the bottom frame with the required pipes(2) and connectors (13-16).

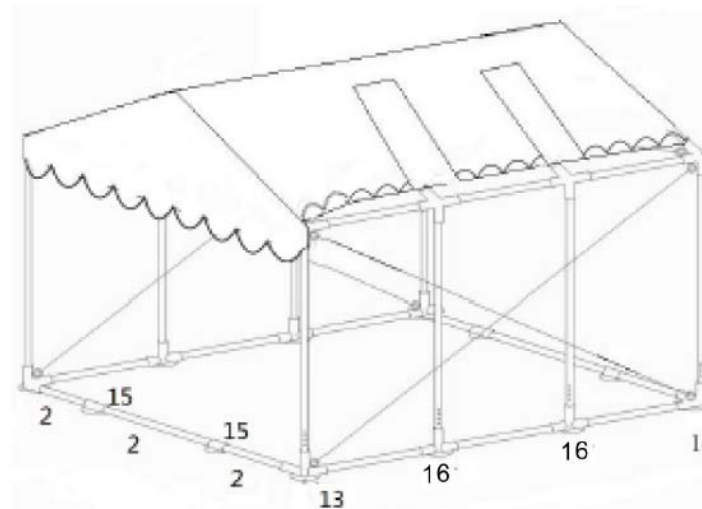

7x7m-2.3 PARTY TENT SEMI PRO

V

Attach the sidewalls to the frame using the bungees.

Attach the endwall directly to the roof with velcro.

Connect the leg covers to the sidewalls and endwalls with velcro as shown.

Use the short ground pegs to fasten the endwalls to the ground.

The guy rope runs from every corner of the tent and is braced to the ground using the spiral pegs.

The super pegs provide the tent with additional tension and stability.

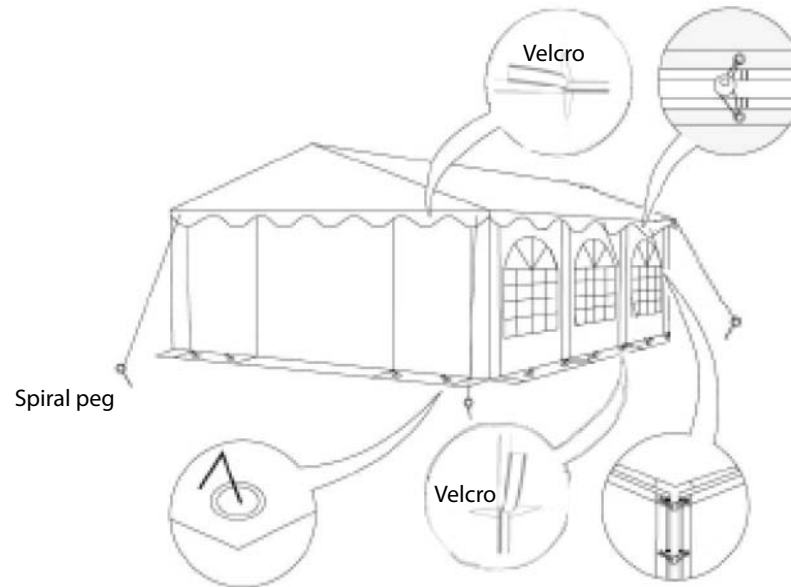

DANCOVER[®]

.com

Contact information

Head office:

Dancover A/S
Nordre Strandvej 119 G
3150 Hellebæk
Denmark

For more information
please visit:
www.dancovershop.com

National contact

Denmark: 70 26 76 20
denmark@dancover.com

UK: 020 8099 7570
uk@dancover.com

Germany: 041 0266 7040
germany@dancover.com

France: 0975 181 800
france@dancover.com

Sweden: 040 233 262
sverige@dancover.com

Finland: 0 931 581 720
suomi@dancover.com

Poland: 22 300 8602
polska@dancover.com

Luxembourg: +49 041 0266 7040
luxembourg@dancover.com

Portugal: 308 800 899
portugal@dancover.com

Spain: 911 436 828
espana@dancover.com

Italy: 02 479 21 198
italia@dancover.com

Switzerland: 0840 000125
schweiz@dancover.com

Austria: 0662 626935
austria@dancover.com

Norway: 231 00 690
norge@dancover.com

Nederland: 0 858 880 524
nederland@dancover.com

Ireland: 0 151 33 003
ireland@dancover.com

Belgium: 0 28 08 08 09
belgique@dancover.com