

DANCOVER[®]

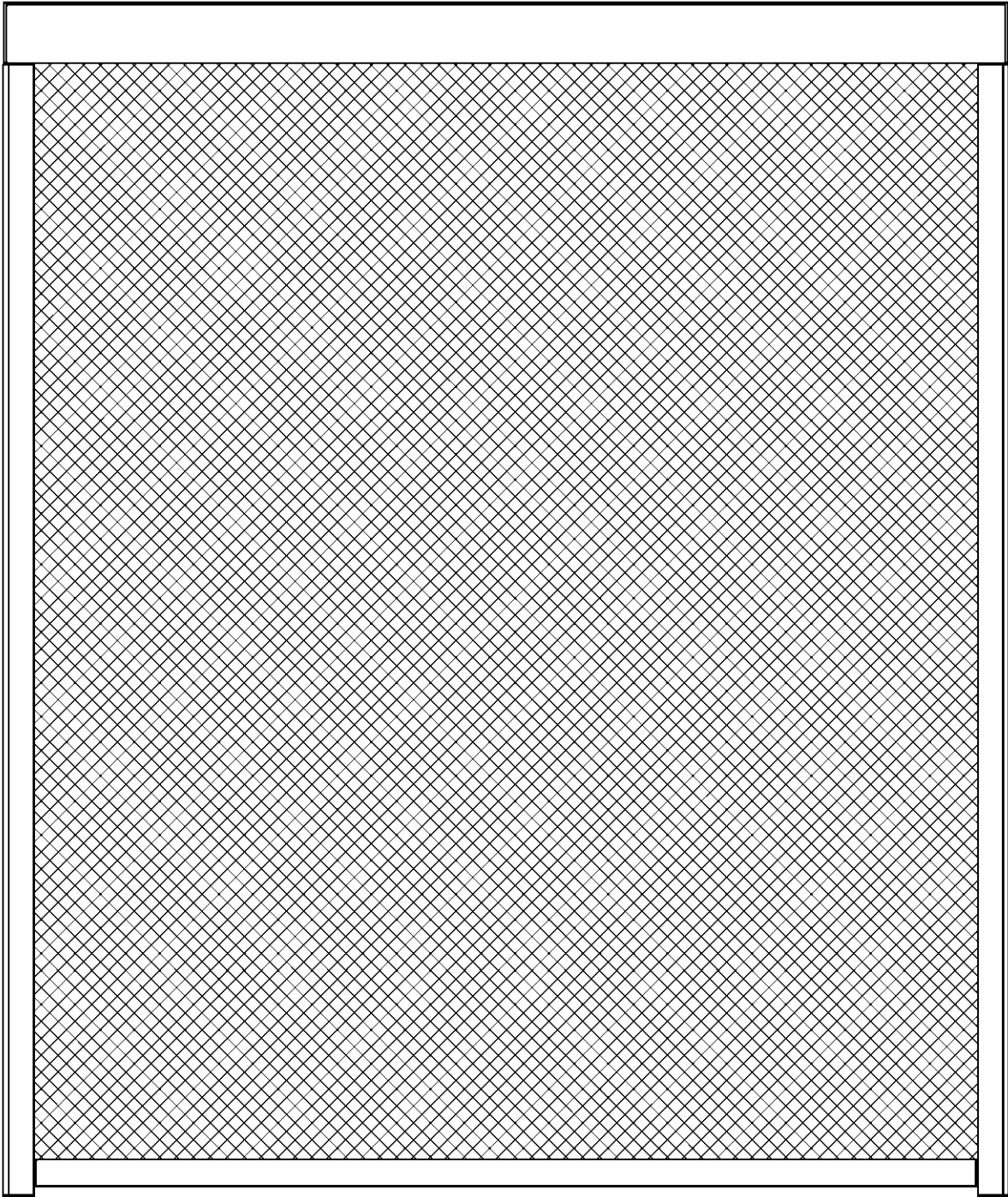





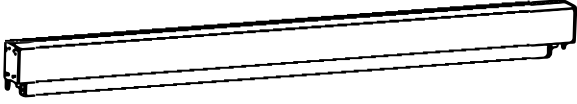

.com

Manual
for
Electrical Screen/Sidewall
for
Gazebo San Pablo

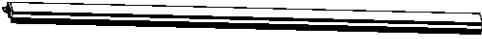
INSTALLATION INSTRUCTIONS

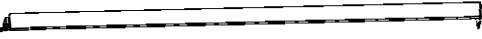
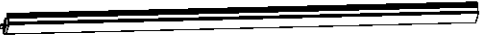

Part list

Part Name		Drawing	Qty
The main frame			1
Guide rail Components (Left)	B1	 Left mounting rail	1
	B2	 Left insertion rail	1
	B3	 Plastic fabric clamping profile	1
Guide rail Components (Right)	C1	 Right mounting rail	1
	C2	 Right insertion rail	1
	B3	 Plastic fabric clamping profile	1
Self drilling screw ST4.2*25	D		6
Remote control	E		1
The manual			1

1. Assemble the rails and main frame

As shown below, insert the left / right mounting rail B1/C1 into the convex of the left and right end covers of the main frame respectively.

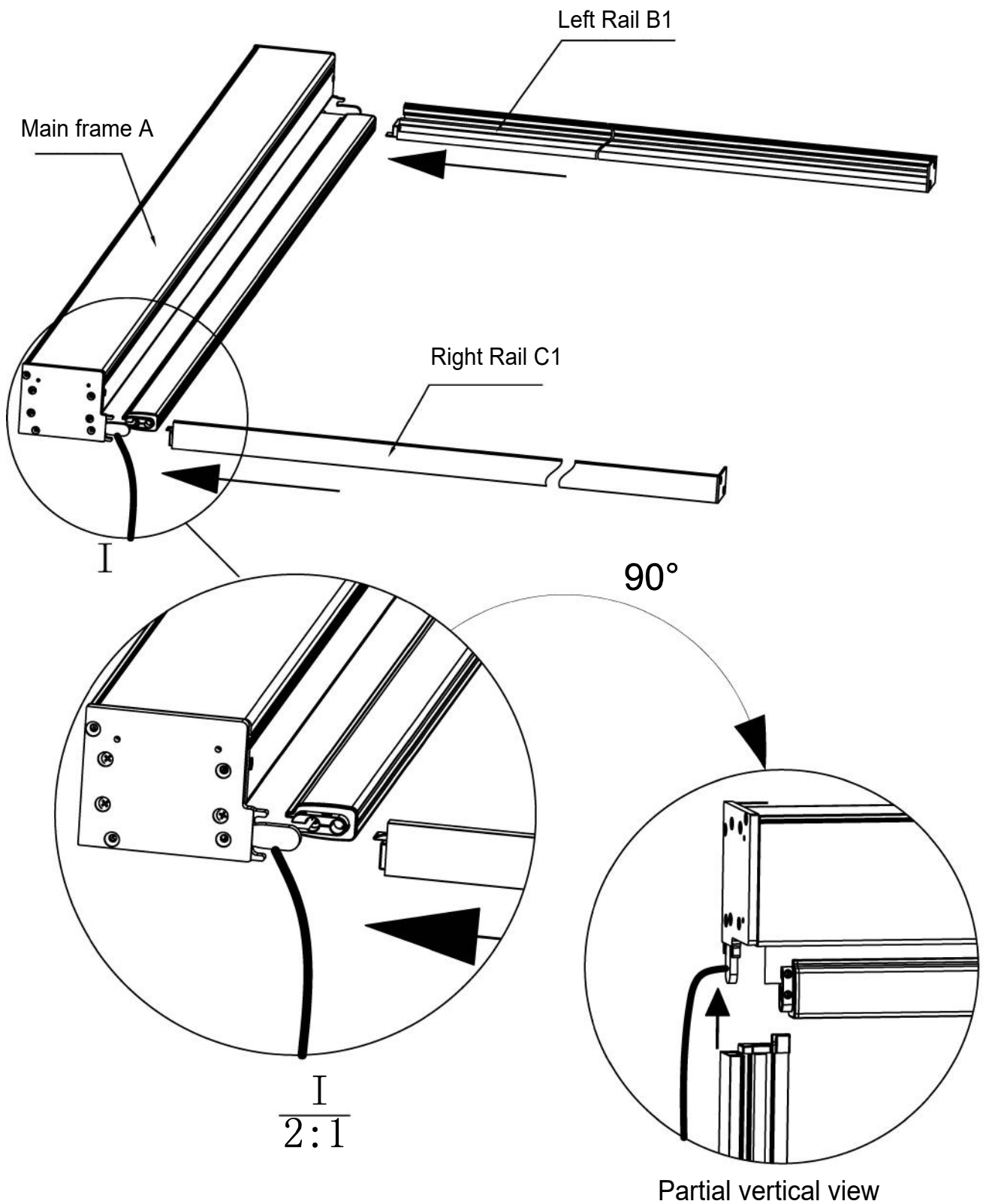

2. Lift the main frame up and move it into the installation area

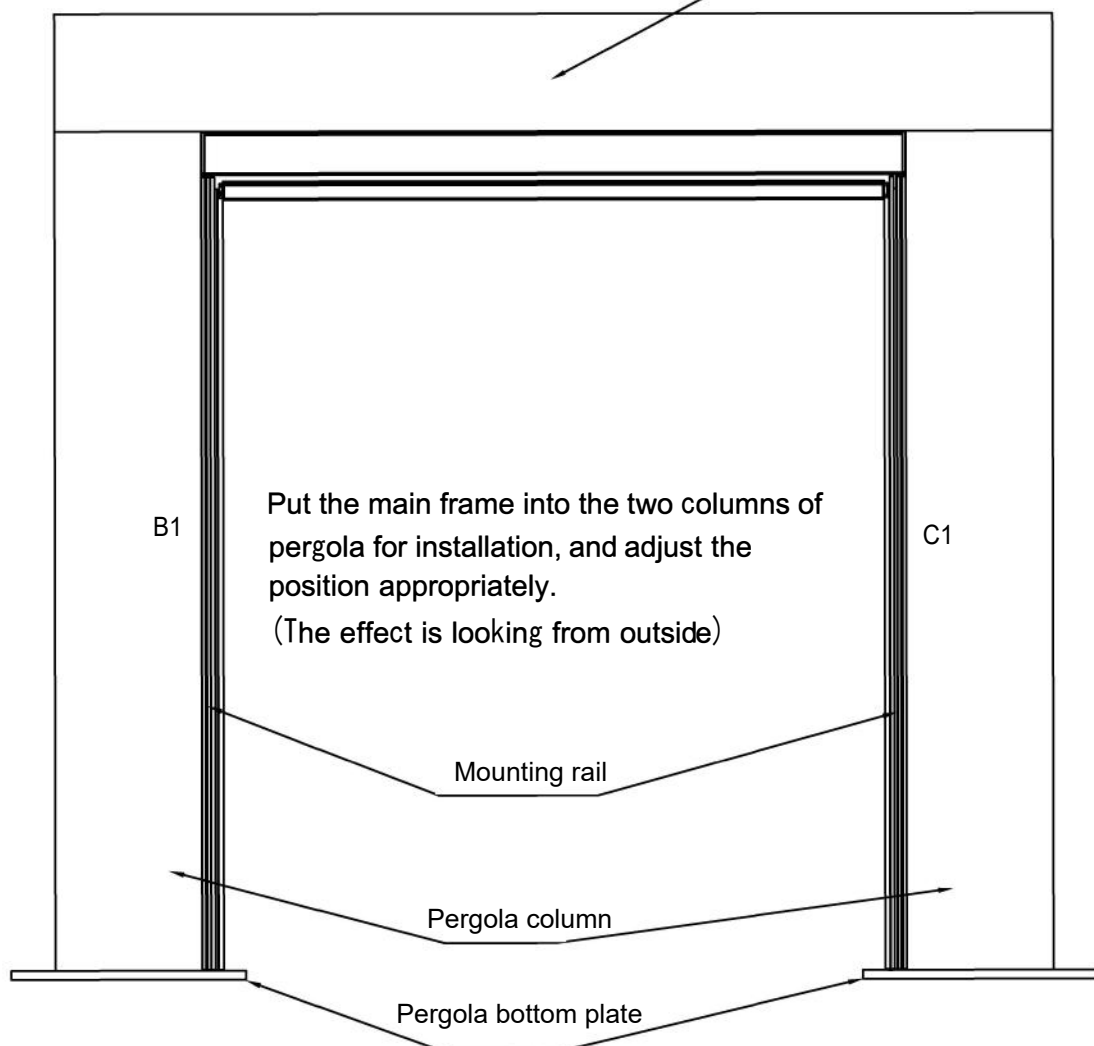
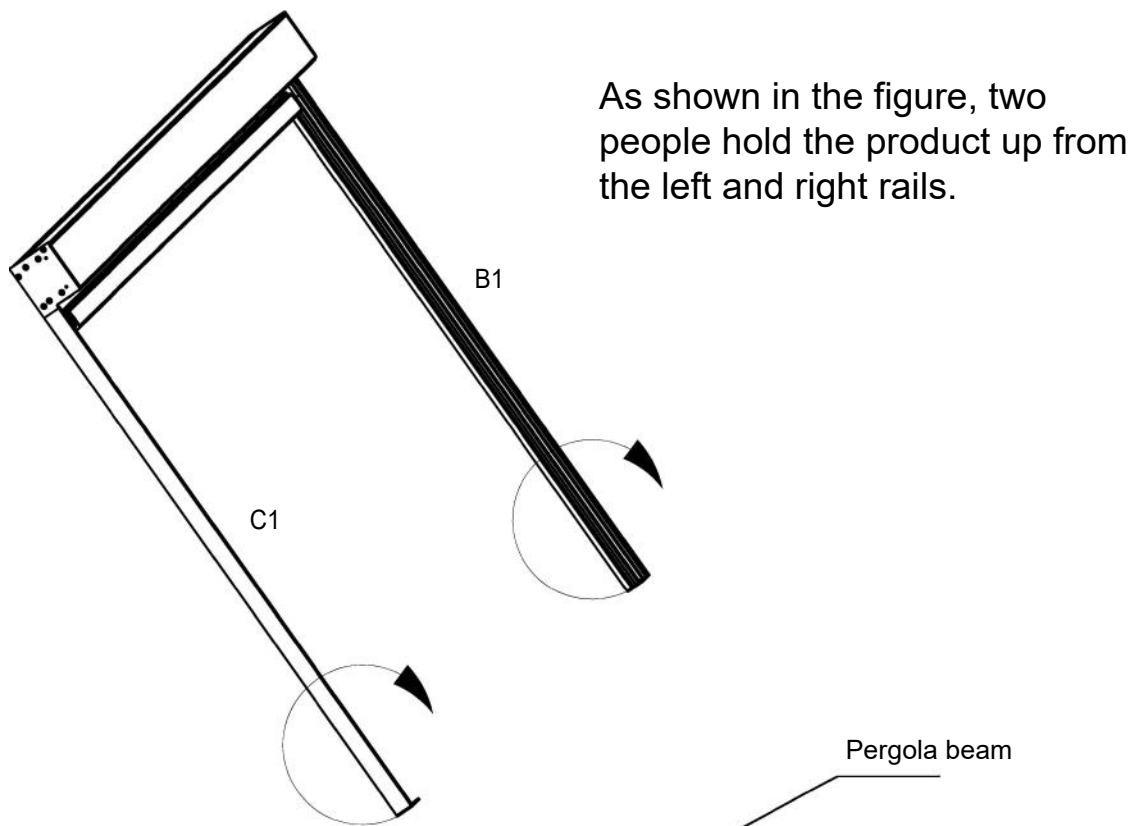

3. Secure the mounting rails B1/C1 to the columns with self-drilling screw D, each side 3 screws and keep them appropriate distance.

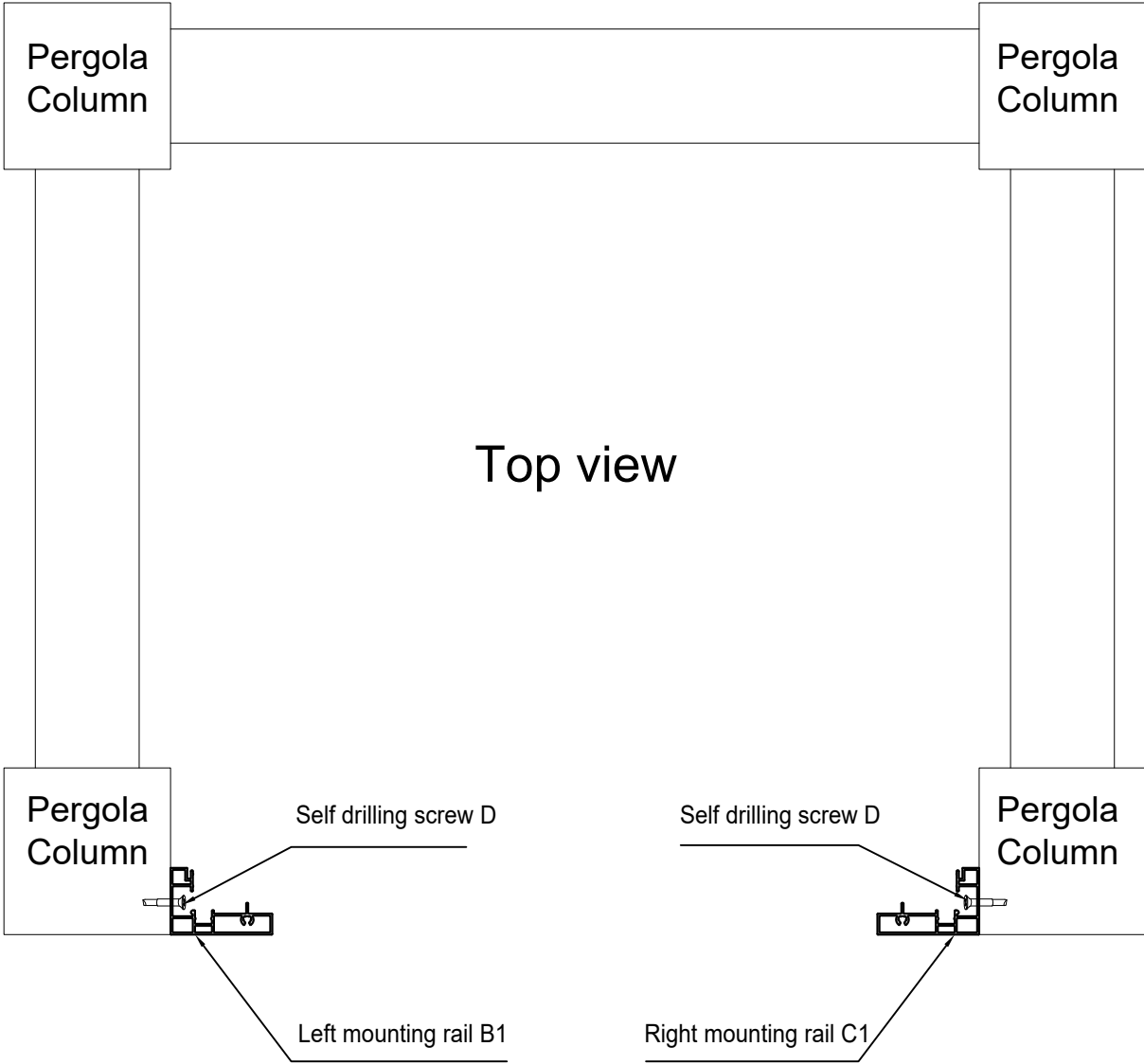

4. Install the plastic fabric clamping profile B3

The left and right plastic clamping profiles B3 are clamped to the zipper edges of the left and right edges of the fabric as shown in the figure below and placed upright in the mounting assembly.

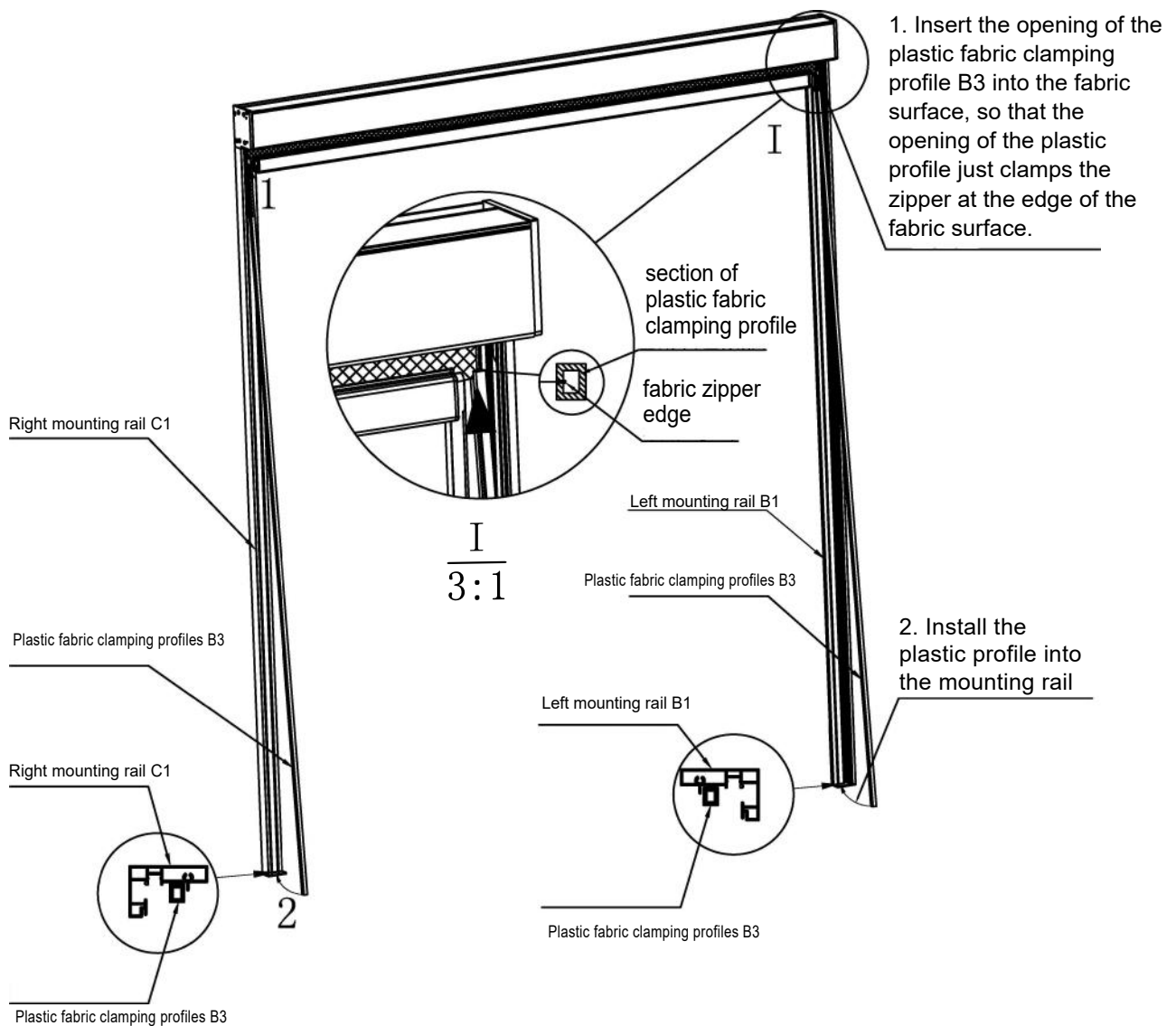

5. Plug in and adjust the remote control E to put down the fabric.

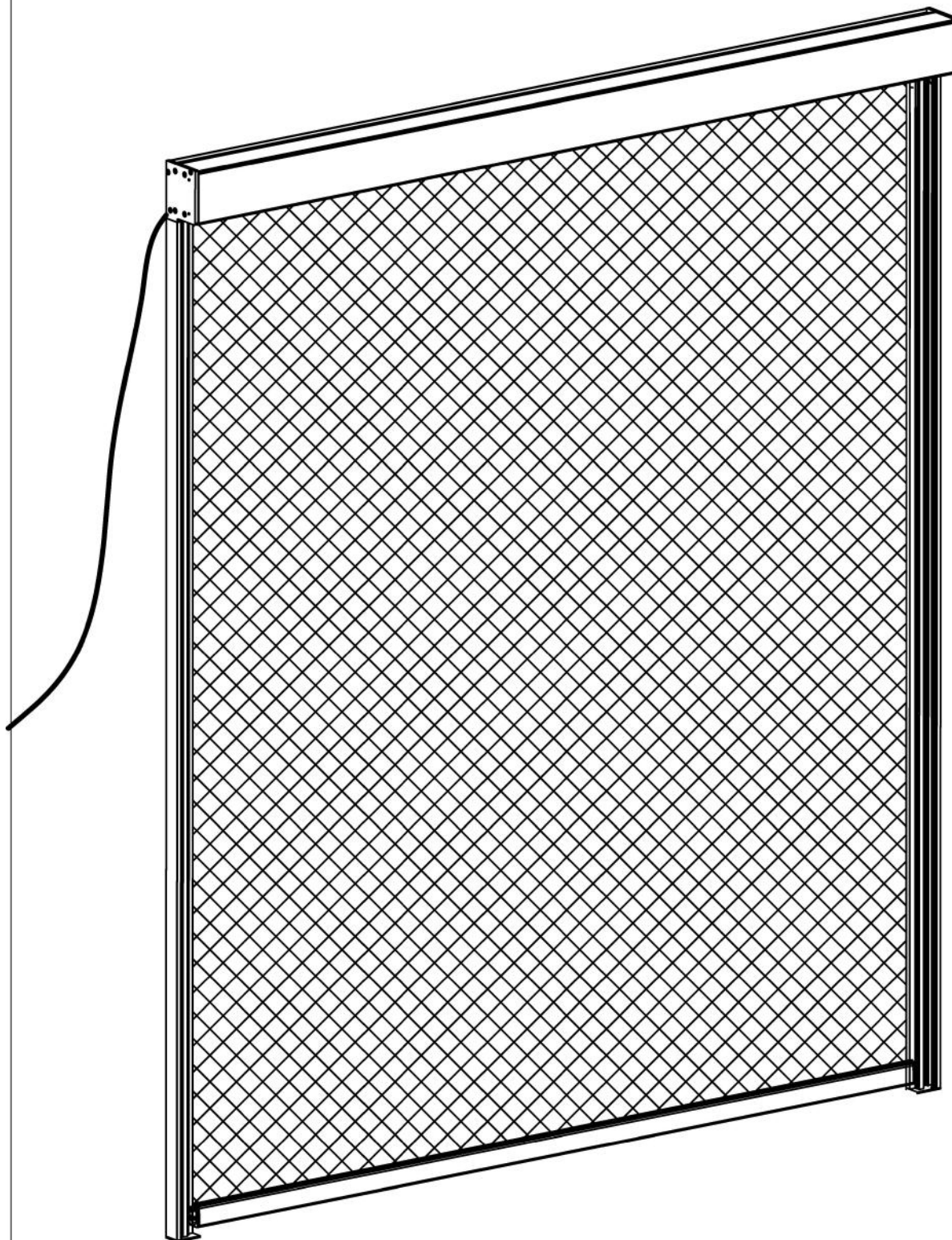

After installing the plastic fabric clamping profile B3 place the fabric completely down in order to adjust the fabric. Then install the insertion rail as described below.

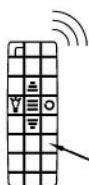

Remote control E

6. Install left/right insertion rail B2/C2

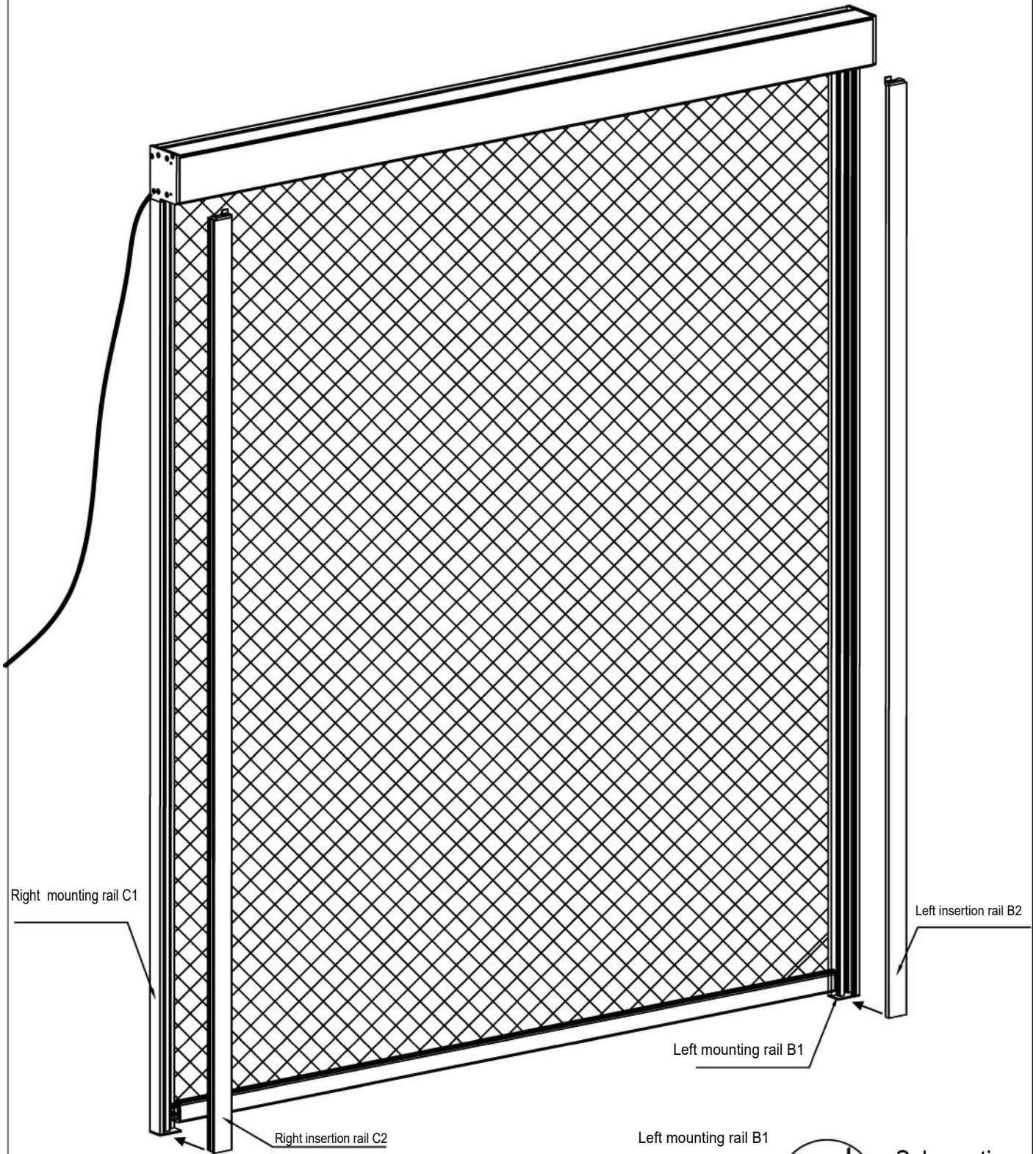

Right mounting rail C1

Left insertion rail B2

Left mounting rail B1

Right insertion rail C2

Right mounting rail C1

Fabric

Plastic fabric clamping profiles B3

Left insertion rail B2

Left mounting rail B1

Fabric

Plastic fabric clamping profiles B3

Left insertion rail B2

Schematic diagram of guide rail section

Schematic diagram of guide rail section

TIP: The left/right insertion rail B2/C2 may be tight during installation. With the aid of a wooden or rubber hammer, tap inward from the bottom to the top to fully snap the left/right insertion rail B2/C2 into place with the left/right stationary rail B1/C1 as shown in the above cross-section.

7. Adjust the remote control E to up and down the fabric, installation completed.

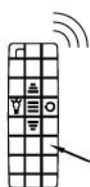
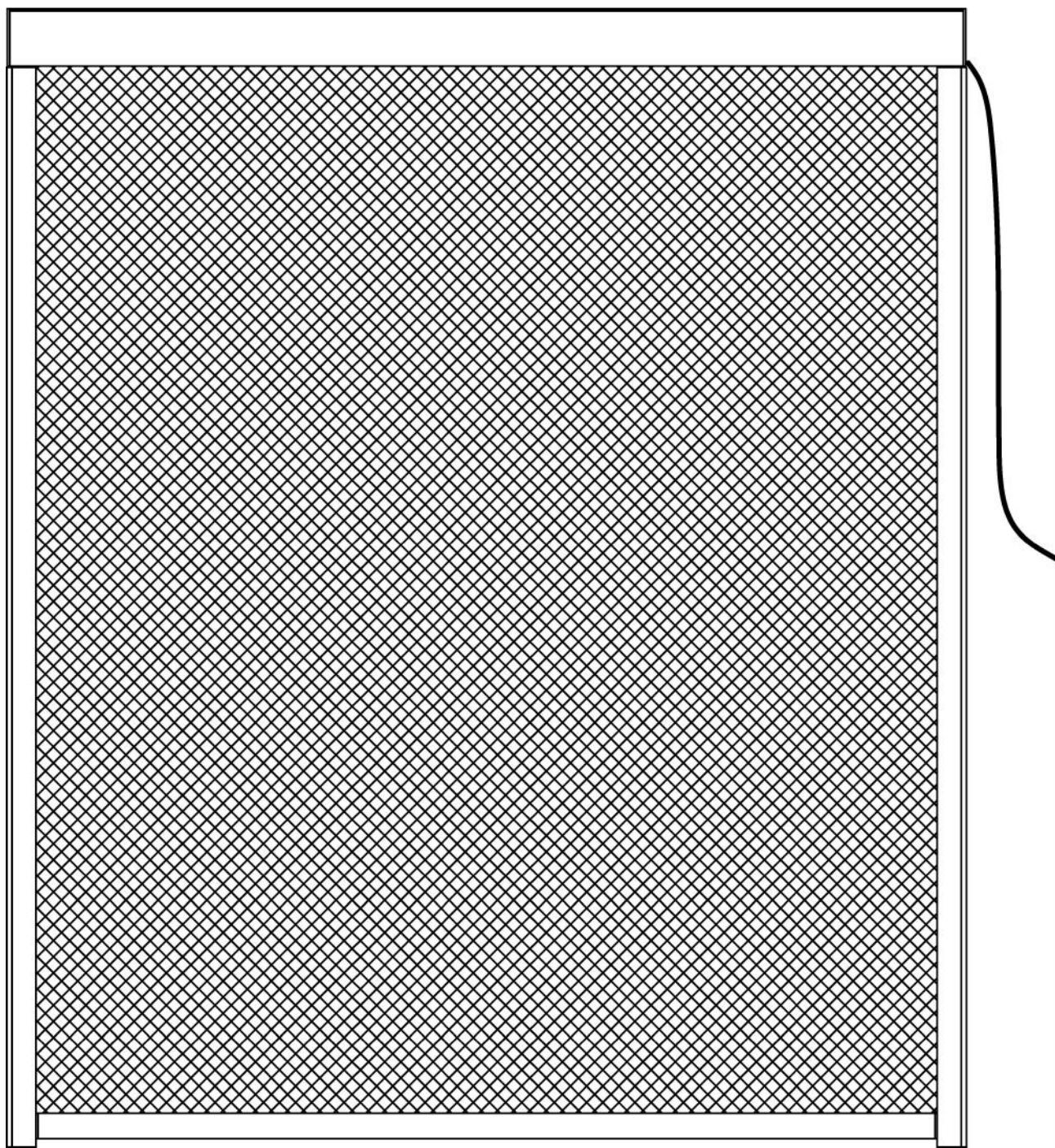

Remote control E

Contact information

Austria



Belgium



Croatia



Denmark



Estonia



Finland



France



Germany



Ireland

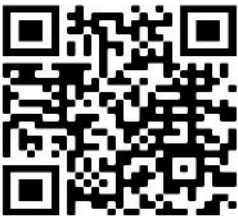

Italy



Latvia



Lithuania



Nederland



Norway



Poland



Portugal



Spain



Sweden



Switzerland



UK

